



Eco-Propel™
Variable Speed Pump Kit
Instruction and Operation
Manual, P/N: 107065-01, Revision 1
 March 03, 2017



P.O. Box 3244
 Lancaster PA 17604-3244
 Telephone 717-239-7642
 Fax 877-501-5212
www.ThermalSolutions.com

Contents

Introduction 2

Installation

- Pre-installation 3
- Installation Procedure 4
- Electrical 5

Front Panel

- General Navigation 9

Setup & Tuning

- Manual Operation 10
- Concert Parameter Adjustment 11
- Pump Parameter Adjustment 13

Trouble Shooting 14

Specifications

- General 15
- Ordering Information 16
- Replacement Parts 16

Application

The Eco-Propel™ Variable Speed Pump Kit has been designed for Apex Condensing High Efficiency Boiler models with Concert™ Boiler Control:

- APX425C**
- APX525C**
- APX625C**
- APX725C**
- APX825C**

Intent

This instruction manual includes detailed functional, installation and setup information. The intended users are application engineers, installing contractors.



Figure 1:
Grundfos Variable Speed Pump



Figure 2:
Taco Variable Speed Pump

Introduction

Functionality

The Eco-Propel Variable Speed Pump Kit is pre-engineered to integrate with boiler firing rate control ensuring efficient temperature control while maximizing electrical energy savings. Boiler pump speed demand is calculated based on supply and return temperatures, and boiler firing rate. Heating systems are designed for a specific differential temperature or delta T across supply and return temperature. Standard fixed speed boiler pump systems allow the differential temperature to change as the boiler load changes. For example, as the boiler firing rate modulates from high to low fire standard fixed speed boiler pumps over pump and cause system differential temperature to drop. Eco-Propel continuously adjusts pump speed to maintain a constant differential temperature as the boiler firing rate modulates. The result lower return temperature boosting efficiency and minimized electrical usage. The Eco-propel system provides the following benefits:

- Matches Boiler Pump to Boiler. Boiler pumps are generally oversized. The Eco-propel kit is factory tuned to produce an optimized match of boiler pump to boiler and piping. Energy is saved by preventing over pumping over the full modulation range.
- Helps Increase Boiler Efficiency: Standard, constant speed boiler pumps allow return temperature to increase as firing rate is reduced. This is due to the excessive water flow rate across the boiler. Eco-Propel decreases pump speed as the firing rate decreases helping to maintain more efficient, lower return temperatures.

Kit Overview

The Eco-Propel kit is field installed to any Apex Model C Condensing High Efficiency Boiler. The Kit includes ECM type variable speed boiler pump (see Figure 1, Grundfos Variable Speed Pump or Figure 2, Taco

Variable Speed Pump), control hardware and wiring harness. The Eco-Propel Variable Speed Pump Kit uses a standard 0-10Vdc output to interface with the variable speed boiler pump.

Fault Tolerant Design

Hardware is designed to ensure continued heat supply in the event of 0-10Vdc signal or communication failure as the boiler pump speed is forced to full flow upon a loss of signal from the control. Therefore a loss of control or a disconnected wire will not cause loss of boiler availability.

Factory Default

The Eco-Propel is factory set to deliver 20 degrees differential temperature from high fire to low fire conditions while maintaining minimum flows with standard primary-secondary piping lengths, refer to figure 3.

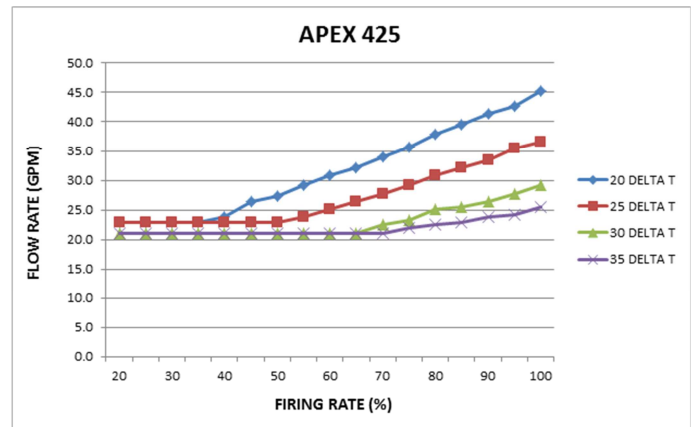

Figure 3: Pump Flow vs. Firing Rate

(Note: Heat exchanger minimum flow requirements prevent flow from being reduced below 20 GPM.)

Easy Site Adjustment

Using the boiler mounted Concert touch screen display; the user may adjust differential temperature setpoint from 20 to 35 F. Additionally, the user may adjust pump speed in “manual” mode and “bias” pump speed when running in “automatic”.

Installation

Pre-Installation

NOTE: Before installing read this installation manual and keep for future reference.

WARNING

Eco-Propel Kit must be installed and serviced by a professional service technician. Improper connections could create an electrical hazard, which could cause serious injury, property damage, or death.

NOTICE

Utilizing any other variable speed pump would result in improper system performance, and may cause high limit shutdowns.

This equipment shall be installed in accordance with local regulations. These regulations shall be carefully followed in all cases. Authorities having jurisdiction shall be consulted before installations are made.

The following terms are used throughout this instruction manual to bring attention to the presence of hazards of various risk levels, or to important product information concerning product life.

HAZARD LEVEL	INDICATION
DANGER	Indicates an imminently hazardous situation which, if not avoided, will result in death, serious injury or substantial property damage.
WARNING	Indicates a potential hazardous situation which, if not avoided, could result in death, serious injury or substantial property damage.
CAUTION	Indicates a potential hazardous situation which, if not avoided, may result in moderate or minor injury or property damage.
NOTICE	Indicates a special instructions or installation, operation, or maintenance which is important but not related to personal injury hazards.

WARNING: Improper installation, adjustment, alteration, service or maintenance can cause property damage, injuries or loss of life. For assistance or additional information, consult a qualified installer, or service agency. Read these instructions carefully before installing.

Installation

Installation Procedure

Mechanical

1. Install Primary/Secondary Piping: Boiler **MUST** be installed in a **Primary/Secondary** piping configuration to ensure sufficient flow through the boiler's heat exchanger. The primary loop must isolate the boiler from system piping via a closely spaced tee. For more information refer to the "Piping" section in the Apex Boiler Installation and Operation Manual.

NOTICE

Utilizing any other near boiler piping configuration would result in improper system performance, and may cause high limit shutdowns. Pump sizing and flow requirements are based on 50 equivalent feet of near boiler piping; approximately 20 ft. straight pipe, (4) 90° elbows, and (2) full port valves.

2. Unpack Eco-Propel Kit: Always lift directly on the pump head or the cooling fins when handling the pump, if necessary use lifting equipment. Do not discard custom insulation shell; set aside for use after installation is completed.
3. Recommended tools for installation:
 - Torx screwdriver
 - Flathead screwdriver
 - Allen Wrench
 - Open-ended wrench
 - Adjustable pipe wrench
 - Pliers, Drill, ½" Drill bit
4. Before attempting to install the pump:
 - Turn off power supply to the boiler.
 - Turn off water and gas supplies at the source.
 - Drain the water from the boiler and the primary loop.
5. For safe and proper operation, pump **MUST** be installed in return piping to the boiler.



Figure 4: Grundfos Recommended Installation Positions

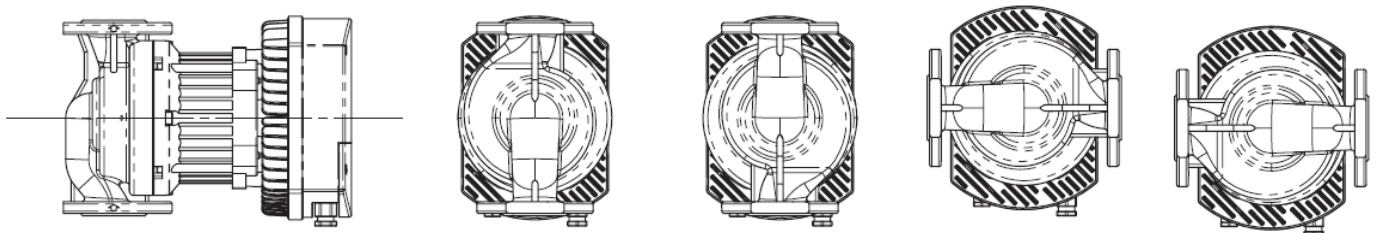

Figure 5: Taco Recommended Installation Positions

Installation

Installation Procedure

6. The pump can be installed vertically or horizontally to fit existing pipe structure. It can also be suspended directly in the pipes, provided the pipework can support the pump weight. Refer to figures 4 and 5.
7. For vertical installation, position pump's housing vertically so that the pump display is facing up. For Horizontal installation, ensure the power-head is level and sits parallel to the floor.
8. To prevent cavitation, provide a minimum of five (5) diameter straight run of pipe on the suction and discharge sides of the pump.
9. Before securing the pump into place, confirm the arrow on the pump motor points towards the boiler's heat exchanger.
10. Place factory supplied gaskets between the end of each pump housing and the adjoining pipes. Use a wrench to secure the pump in place with nuts and bolts provided. For detailed pump installation instruction refer to pump Installation and Operation Manual.

Electrical

1. Remove boiler junction box cover which is located top left side of the boiler. Inside the junction box there are two printed circuit boards (PCB's), 120 VAC Connections on the left and Low Voltage Connections on the right. Refer to figure 6.

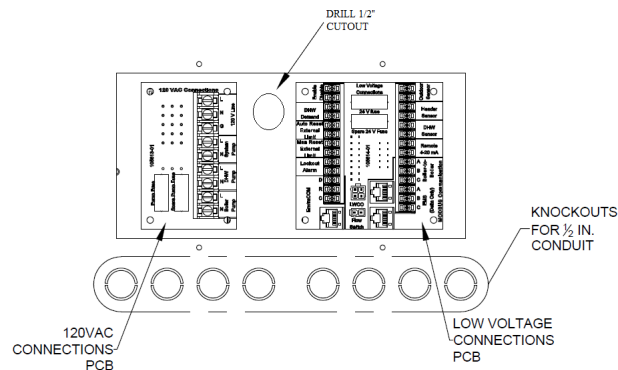

Figure 6: Apex Boiler Junction Box, Located on Upper Left Side of Boiler.

2. Drill a 1/2 inch diameter hole through the boiler inner jacket located in between the two printed circuit boards for field wiring connections. Refer to figure 6.
3. Insert the locking grommet into 1/2"
4. Mount Eco-Propel Control enclosure in the location specified in figure 7.

Installation

Installation Procedure

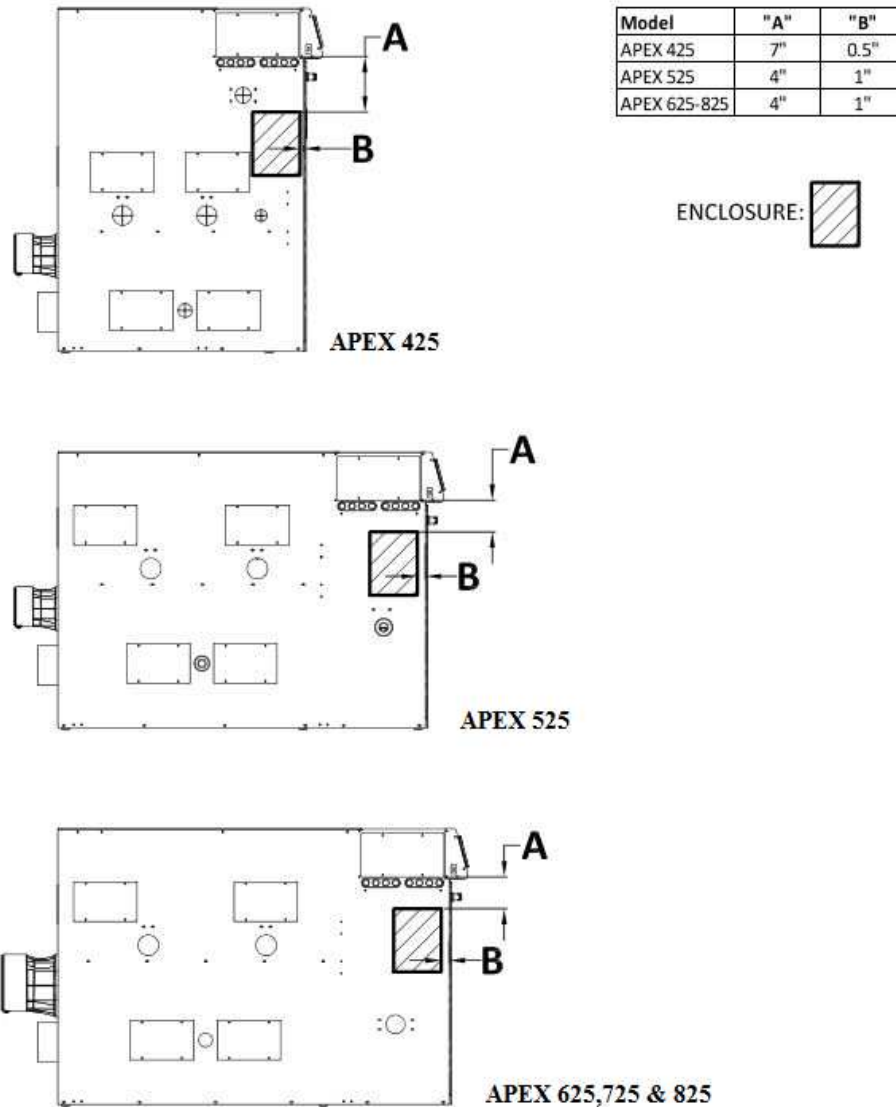

Figure 7: Enclosure Mounting Locations

5. Insert the factory supplied locking grommet into holes on the side of enclosure.
6. Once enclosure is properly secured in place, connect the appropriate wiring to the Eco-Propel Control terminals. Then slide Eco-Propel control onto din-rail.
7. Remove top boiler access panel. Run wire through ½" dia. cutout hole to connect Eco-Propel Control to 24v DC power supply. Use second factory supplied wire harness to connect Eco-Propel Control to the main boiler control.
8. Connect Eco-Propel control to variable speed pump via supplied wires.
9. Supply power to variable speed pump from 120VAC PCB Boiler Pump terminals via field supplied wires.
10. Refer to Eco-Propel Wiring Schematic for more detail.

Installation: Taco Variable Speed Pump

Electrical

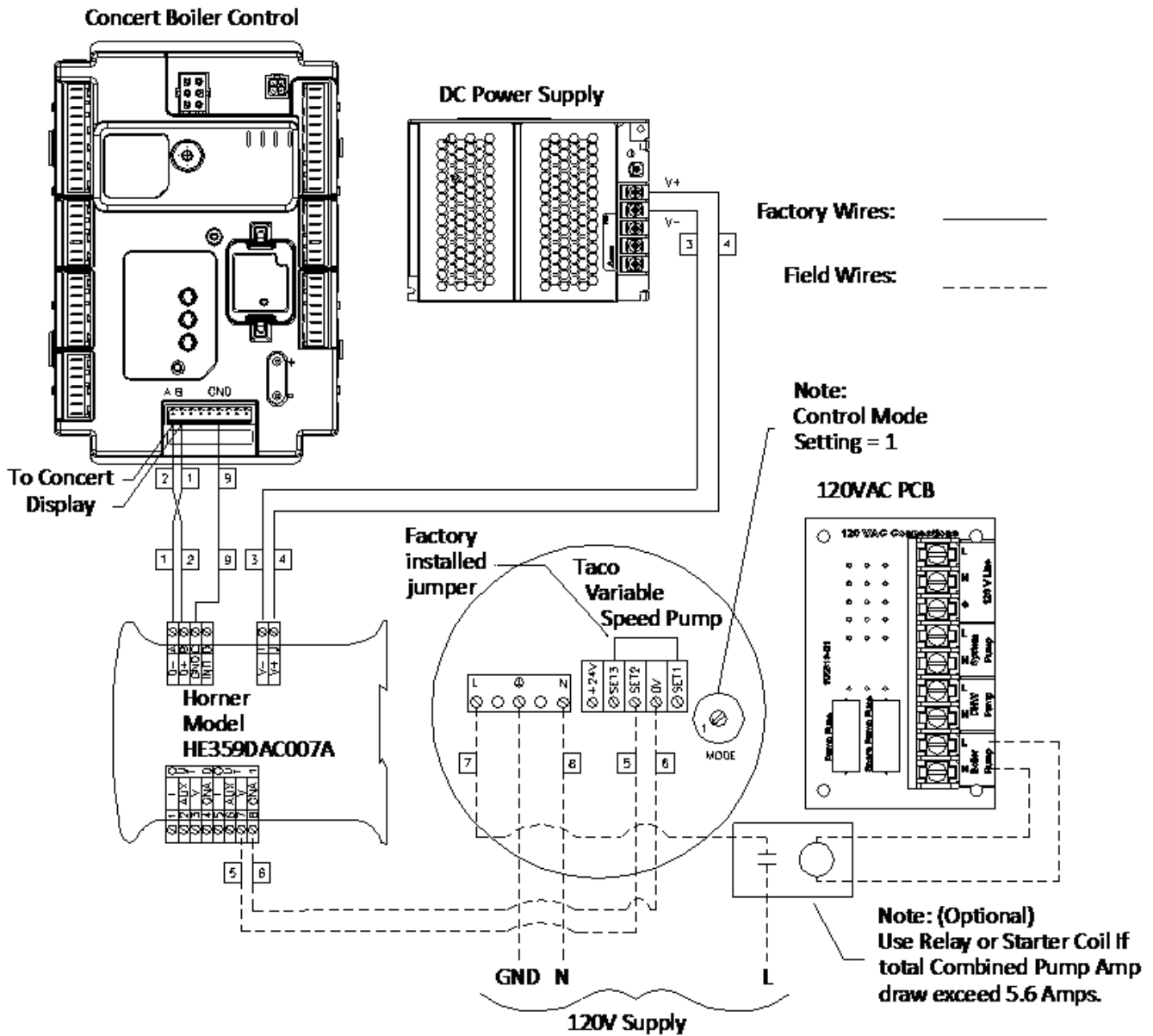

Figure 8: Taco Variable Speed Pump Wiring Schematic

Factory supplied wiring harness connections:
(Factory harness uses 18 AWG, type TEW/AWM Stranded Wire, 105C.)

Wire No.	Wire From		Wire To		Type
	Component	Terminal	Component	Terminal	
1	Horner	[D -]	Boiler Control	J3 MB1 B	RS-485
2	Horner	[D +]	Boiler Control	J3 MB1 A	RS-485
3	Horner	[V -]	24vdc Power Supply	V -	24Vdc-
4	Horner	[V +]	24vdc Power Supply	V +	24vdc+

Field supplied wiring connections:

Wire No.	Wire From		Wire To		Type
	Component	Terminal	Component	Terminal	
5	Horner	7 [V]	Variable Speed Pump	SET2	0-10Vdc
6	Horner	8 [GNA]	Variable Speed Pump	0 V	0-10Vdc
7	Variable Speed Pump	L	120 PCB Boiler Pump	L	120Vac
8	Variable Speed Pump	N	120 PCB Boiler Pump	N	120Vac
9	Horner	GND	Boiler Control	GND (J3, TR: #6)	GND

Installation: Grundfos Variable Speed Pump

Electrical

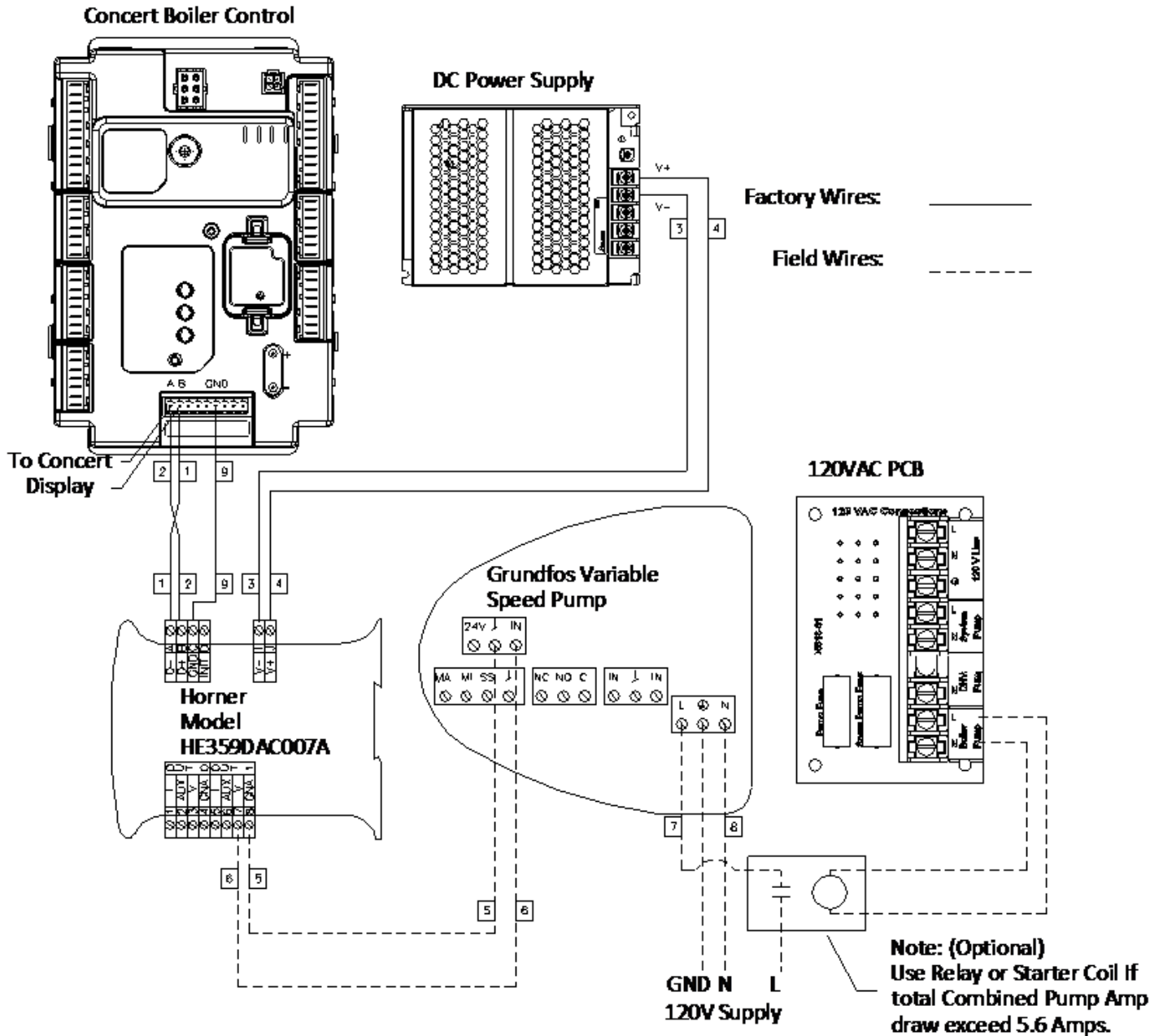

Figure 9: Grundfos Variable Speed Pump Wiring Schematic

Factory supplied wiring harness connections:

(Factory harness uses 18 AWG, type TEW/AWM Stranded Wire, 105C.)

Wire No.	Wire From		Wire To		Type
	Component	Terminal	Component	Terminal	
1	Horner	[D -]	Boiler Control	J3 MB1 B	RS-485
2	Horner	[D +]	Boiler Control	J3 MB1 A	RS-485
3	Horner	[V -]	24vdc Power Supply	V -	24Vdc-
4	Horner	[V +]	24vdc Power Supply	V +	24vdc+

Field supplied wiring connections:

Wire No.	Wire From		Wire To		Type
	Component	Terminal	Component	Terminal	
5	Horner	8 [GNA]	Variable Speed Pump	Ground T	0-10Vdc
6	Horner	7 [V]	Variable Speed Pump	IN	0-10Vdc
7	Variable Speed Pump	L	120 PCB Boiler Pump	L	120Vac
8	Variable Speed Pump	N	120 PCB Boiler Pump	N	120Vac
9	Horner	GND	Boiler Control	GND (J3, TR: #6)	GND

Front Panel

General Navigation

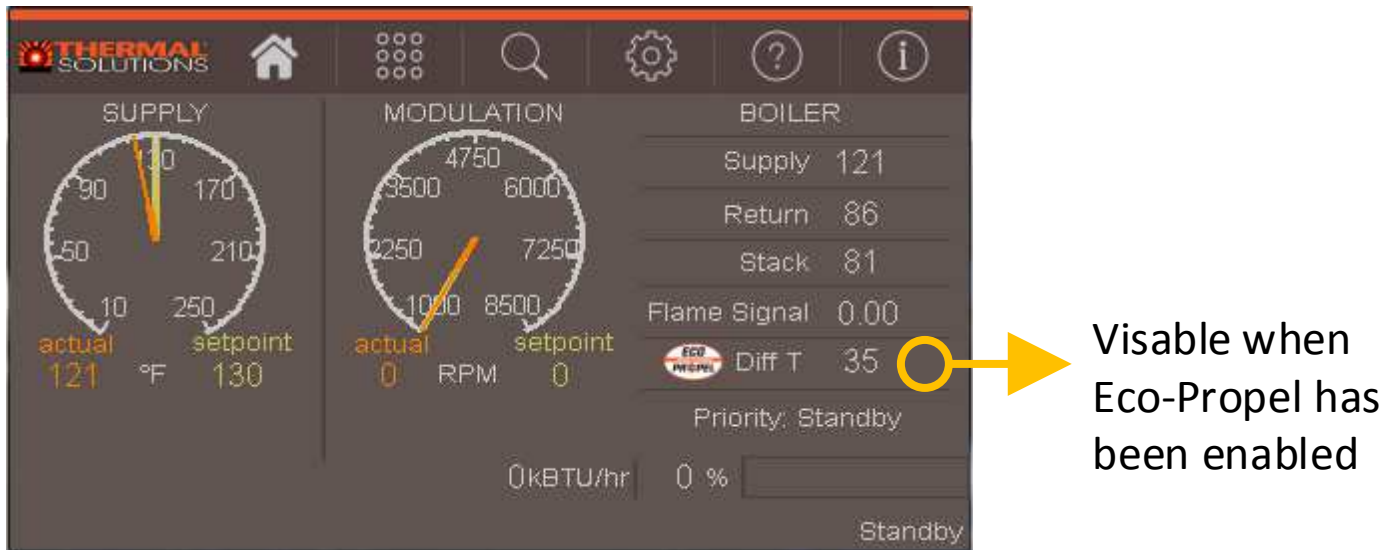



Figure 10: Concert Display Home Screen

Home Screen

The Home screen shows provides the following Eco-Propel features:

- Status:** When the Horner Eco-Propel Control, (control), is connected and communicating the display shows the Eco-Propel logo and differential temperature status.
- Adjust Page Link:** The  Adjust icon provides access to the Adjust menu and the Variable Speed Pump adjustment screen. Pump setup features include pump type selection and differential temperature setpoint. Additionally, the Adjust menu provides access to the Tune menu and the Variable Speed Pump operation screen. This screen is used to manually adjust pump speed and adjust pump control bias.
- Help Page Link:** The  Help icon provides access to the Help menu and the Variable Speed Pump help screen. The pump help screen is provided to alert the user of a loss of pump control and assist in pump setup.

Setup & Tuning

Manual Operation

The pump speed may be adjusted manually using the Operation screen. The user may select Low or High speeds, or adjust pump speed anywhere between low and high;

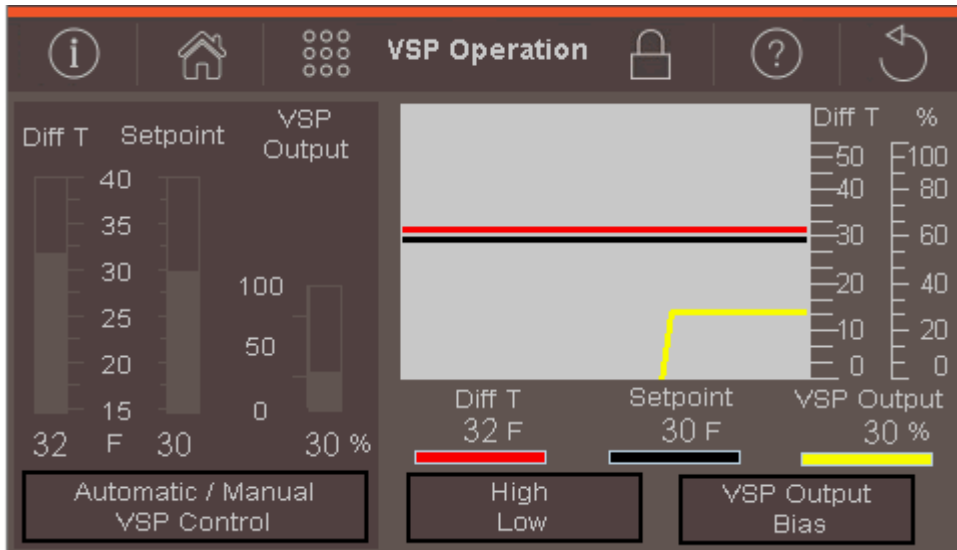

Figure 11: Variable Speed Pump (VSP) Operating Screens

Bar Graph & Trend

Differential Temperature, Active Setpoint & Pump Speed demand.

Automatic / Manual

After selecting Manual Mode the User may adjust pump speed manually.

High / Low

After selecting Manual Mode the High or Low buttons drives pump speed to High and Low speed position for differential temperature testing.

VSP Output Bias

VSP Output Bias allows adjustment VSP Demand while the pump is in “Auto” mode. The Bias has the following effect on differential temperature:

Increase Bias: Pump speed increases and differential temperature is decreased.

Decrease Bias: Pump speed decreases and differential temperature is increased.

NOTE: Manual control mode locks pump speed to a fixed speed. The control stays in manual even through a power cycle. Select Automatic when commissioning is complete.

Setup & Tuning

Concert Parameter Adjustment

Login to Adjust Parameters

Control operation may be tailored to suit the application by adjusting parameters. To adjust parameters select the ADJUST icon located throughout the display.



Press ADJUST icon to review and adjust all parameters.

Parameters are password protected to discourage unauthorized or accidental changes to settings. User login is required to adjust these settings. Parameters are locked and login requirement is shown when the padlock icon is not green.

- Press the Lock icon to access password screen.
- Use keypad to enter Password.
- Press Enter Key when complete.

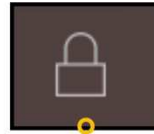

Login is Required
Select Icon to enter password.



Select dark gray box and Enter Password
Factory = 86
Supervisor = 76

Login is Complete
Parameters may be adjusted



Figure 12: Security System

Editing parameters is accomplished as follows:

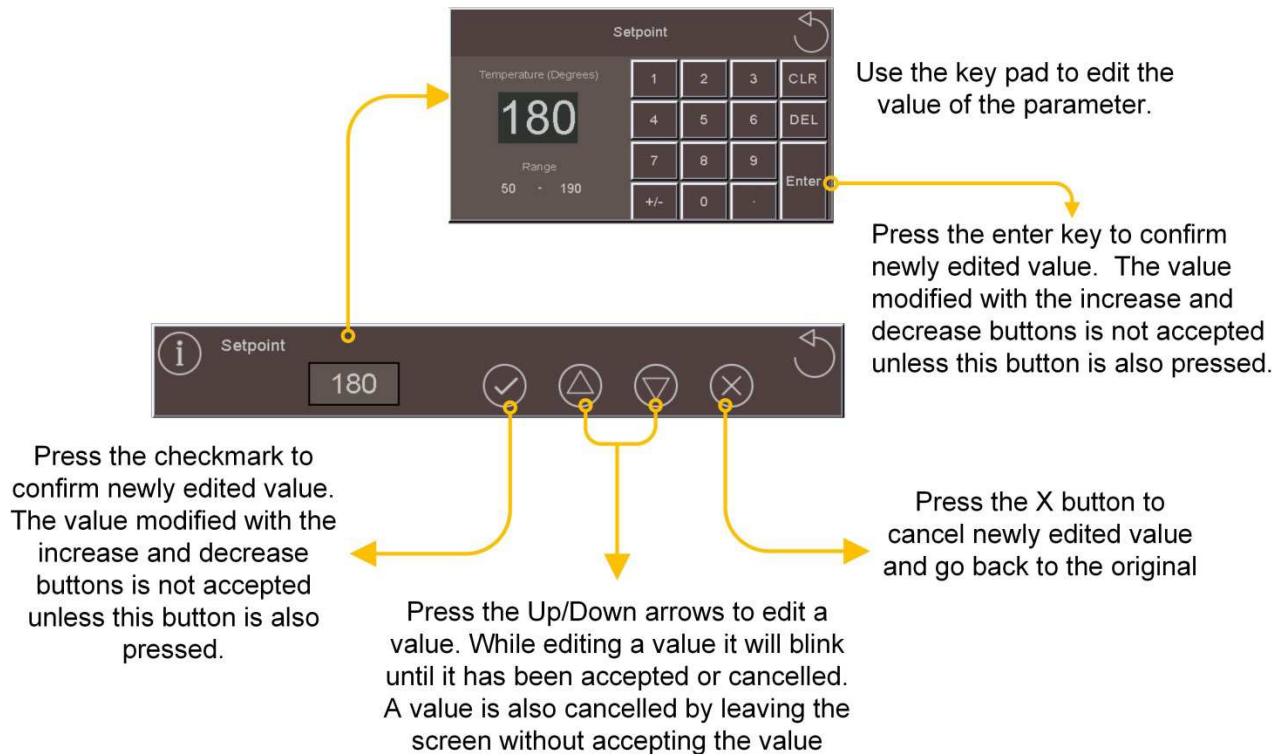



Figure 13: Adjusting Parameters

Setup & Tuning

Concert Parameter Adjustment

From the ADJUST menu select the following buttons to view and adjust parameters.

Press  to adjust the following parameters.

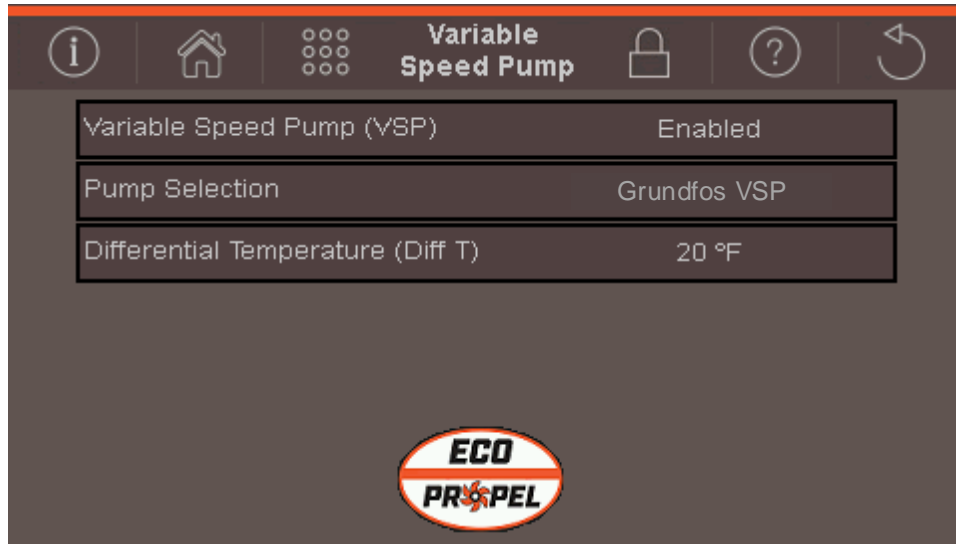

Figure 14: Variable Speed Pump Adjustment Screen

Factory Setting	Range / Choices	Parameter and Description
Disabled	Disable, Enable	Variable Speed Pump (VSP) Enable/Disable Enable – Variable Speed Pump Output is generated and communication alarm is monitored. Disabled – Variable Speed Pump Output is disabled and communication alarm is not monitored.
Taco	Taco, Grundfos	Pump Selection Taco – Scaling required for Taco pump are set. Grundfos - Scaling required for Grundfos pump are set.
20 F	20 F, 25 F, 30 F, 35F	Differential Temperature Setpoint Target differential temperature for variable speed pump control.

Setup & Tuning: For Grundfos Variable Speed Pump, *not provided by Thermal Solutions.*

The following selections must be made when using the Grundfos Magna3 40-120 Variable Speed Pump:

1. "Setpoint" 100% (Analog Input)
2. "Constant Curve"
3. "External Setpoint Influence"

Selecting "Setpoint 100%", "Constant Curve" & Linear with MIN.

4. Press Home Icon to go to "Home" menu.



Figure 15: Home Icon

5. Press right arrow, ">" button until "Settings" Tab is displayed.
6. Press down arrow, "v" until "Setpoint" is displayed.
7. Press "OK". Press "OK", again.
8. Use arrow keys to change setpoint to 100 %.
9. Press "OK".

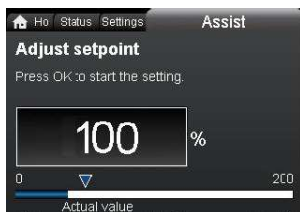

Figure 16: Press "Ok" to select Setpoint.

10. Press left arrow, "<" key" to come out.
11. Press down arrow, "v" until "Control Mode" is displayed. Then press "OK".
12. Press down arrow, "v" until "Constant Curve" is displayed. Then press "OK".



Figure 17: Press "Ok" to select Constant curve

Taco Setup: For Taco Variable Speed Pump, **Not Provided by Thermal Solutions.**

The following selections must be made when using the Taco Variable Speed Pump:

Located under the bottom cover of the variable speed pump is a control mode knob. Remove bottom two screws to take away the cover. Adjust the control knob to the Mode "1" position. Refer to wiring diagram for location of knob and correct position of jumper. Re-install the cover and screws.

Troubleshooting

13. Press left arrow, "<" key" to come out.
14. Press down arrow, "v" until "Setpoint Influence" then press "OK",
15. Press "OK" to select "External Setpoint Function"
16. Press down arrow, "v" to select "Linear with Min" then Press "OK"



Figure 18: Press "Ok" to select Linear with MIN

Selecting "External Setpoint Influence":

1. Press Home Icon to go to "Home" menu.
2. Press right arrow, ">" key until "Assist" Tab is displayed.
3. Press down arrow, "v" key until "Setup, Analog Input" is displayed. Then press "OK" key.
4. Press right arrow, ">" key.
5. Press down arrow, "v" key until "External Setpoint Influence" is displayed. Then press "OK" key.

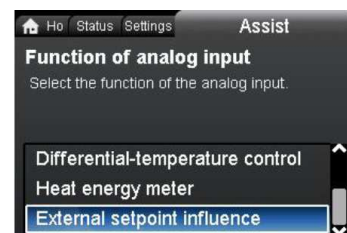

Figure 19: Press "Ok" to select External Setpoint Influence.

6. Press right arrow, ">" key until "0-10Vdc" is displayed. Then press "OK" key.
7. Press right arrow, ">" key.
8. "Summary" screen will appear, press "OK" key.
9. "Assist has been carried out" notification screen will appear momentarily.

Faults are investigated by selecting the “Help” button from the “Home” screen. When a fault is active the “Help” button flashes red. Continue selecting the flashing buttons to be directed to the Fault cause. When a Variable Speed Pump related fault is present the “Variable Speed Pump Status” icon will flash. Select the icon to determine the cause of fault and suggested correction. The following Help screens are provided.

Note: The Eco-Propel control system consists of a Concert Control, Concert4 Display and Horner Smartmod Modbus to 0-10Vdc converter output to the variable speed pump. Modbus communication is required to produce the variable speed pump output.

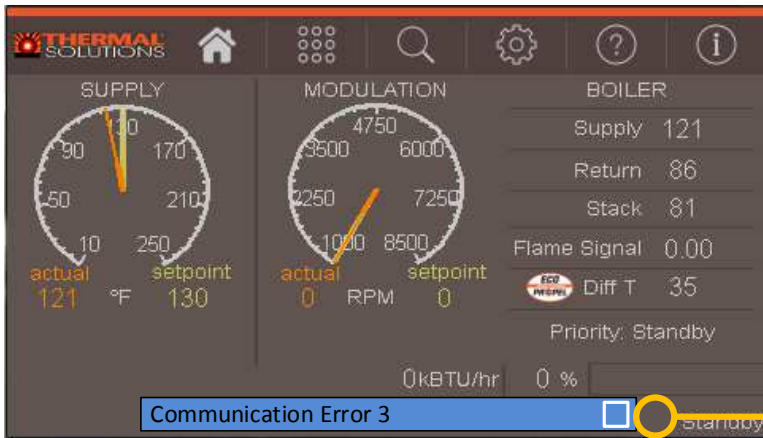

Figure 20: Communication Error Message

If Concert4 Display loses communication with Horner Smartmod, this message will appear 5-6 times before Eco-Propel communication is turned OFF. (If communication is lost while on the “Variable Speed Pump Operations” page, message will appear more than 6 times)

If this message continually appears, communication between Concert Display and Control has been lost.

Indication	Condition	Possible Cause
Blank Screen with “Reading” shown	Display lost communication with Concert control	Failure to establish Communication upon display boot-up. Once communication is established, reboot display to read controller and setup display properly.
Communication Error 2	Communication Fault (Concert Control or Eco-Propel)	The display write attempt has failed. Possible causes are that the password level is too low for the parameter being changed, communication is miswired, the controller is un-configured, or has a memory failure.
Communication Error 3	Communication Fault (Concert Control or Eco-Propel)	Display has lost communication with Control or Horner Smartmod. <ul style="list-style-type: none"> - Loose or defective display harness. - Defective Display. - Defective Control. - Incorrect Communication Parameters. (See Boiler Manual)

If there is a loss of Communication between the Eco-Propel Control and the Concert4, the display will alarm the user, stop all communication to the Eco-Propel, and drive the pump to either maximum or minimum speed. Once the issue has been resolved the user must select to re-establish communication with the Eco-Propel. Conversely, if the Control losses communication the display continuously attempts to communicate with the Control.

Troubleshooting (continued)

The following screen is intended to help in the setup of the Variable Speed Pump option:

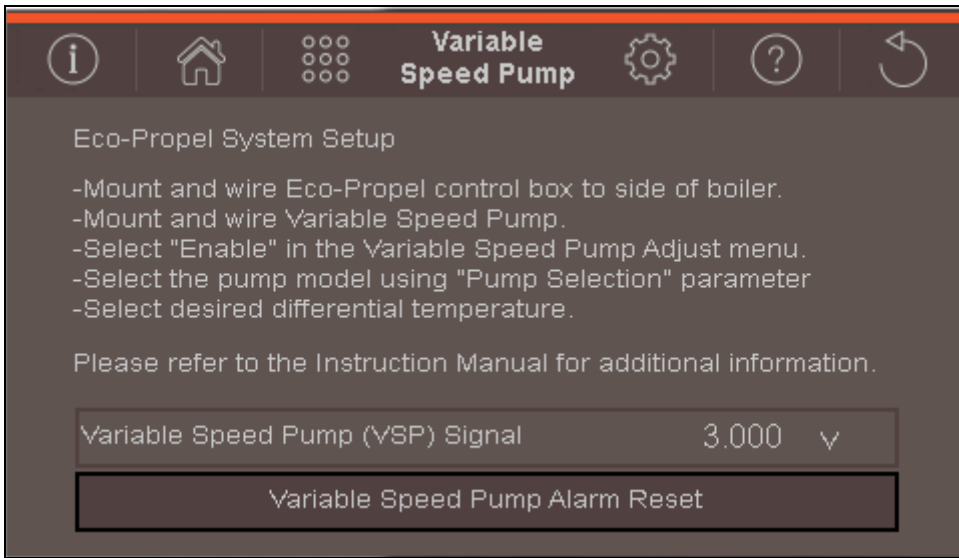

Figure 21: Eco-Propel System Setup Screen

The following screen is shown when there is an active variable speed pump fault:

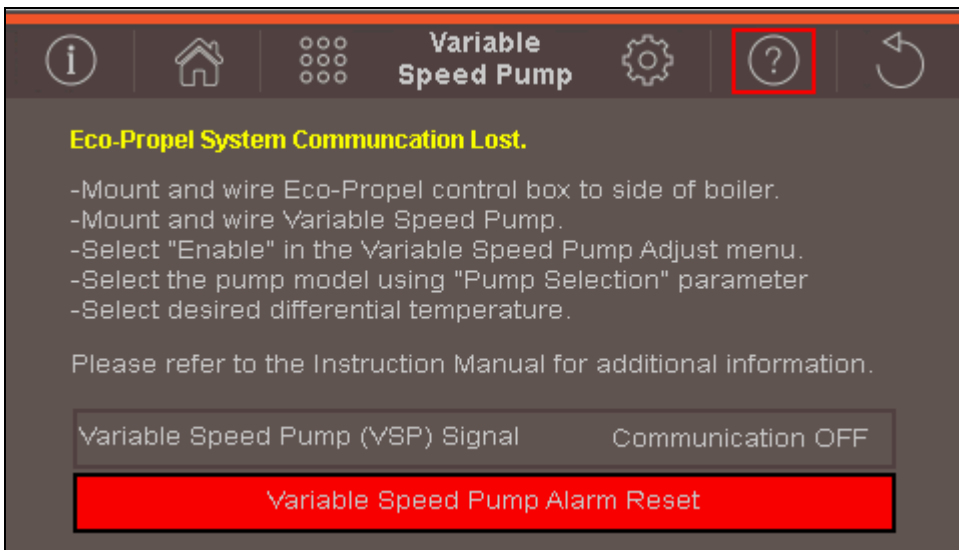

Figure 22: Fault Alarm Screen

Specifications

General

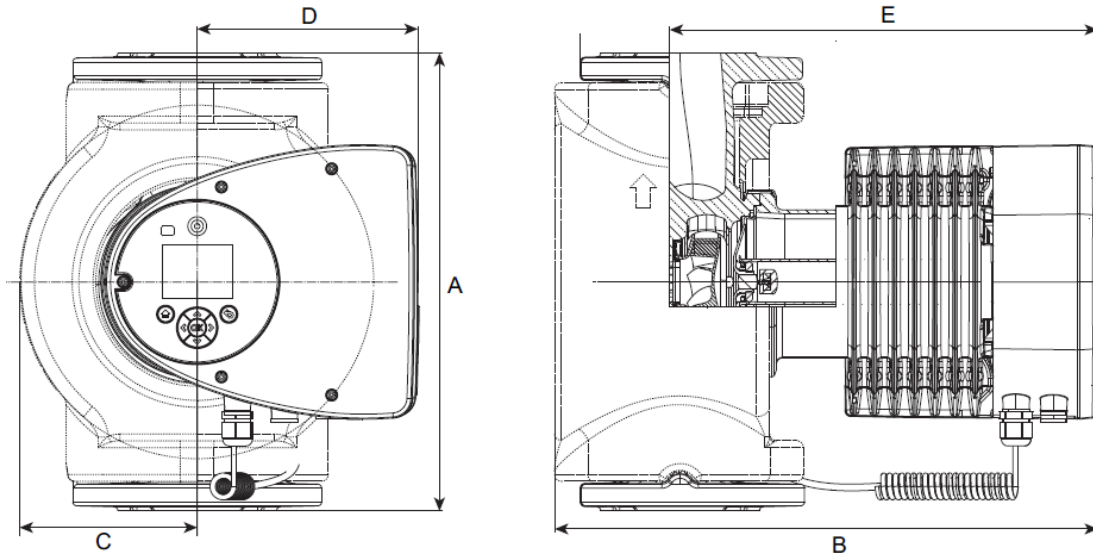

Figure 23: Grundfos Variable Speed Pump Dimensions

DIMENSTIONS [IN]

Part Number	Voltage	Max Amp	Pipe Size	A	B	C	D	E	Weight (lbs.)
107058-01	115 VAC	3.88	1-1/2"	9.8"	14.5"	4.2"	6.5"	12"	28

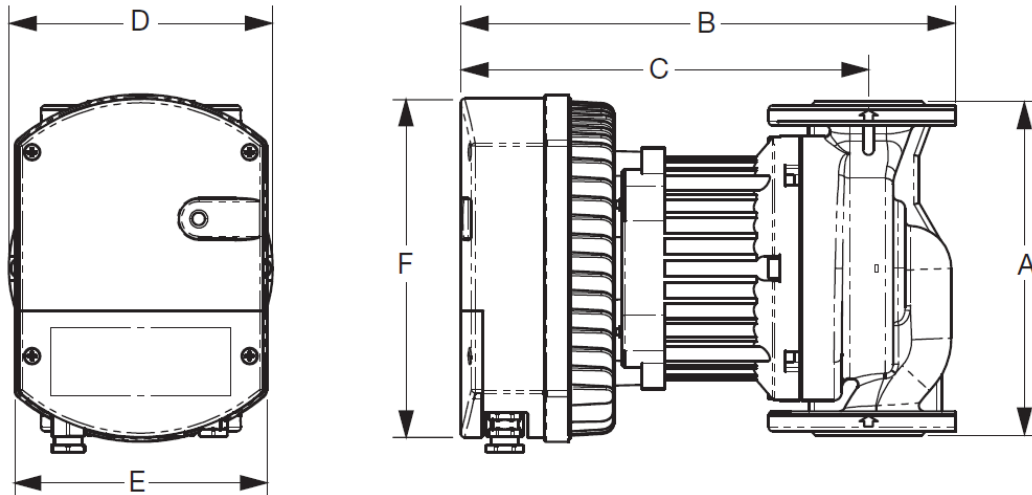

Figure 24: Taco Variable Speed Pump Dimensions

Part Number	Voltage	Max Amp	Pipe Size	A	B	C	D	E	F	Weight (lbs.)
107059-01	115 VAC	6.0	1-1/2"	9.8"	15.2"	12.6"	7.8"	7.4"	10"	57

Specifications

Ordering Information

Part Number	Description
107068-01	Eco Propel Grundfos VSP Kit
107068-02	Eco Propel Taco VSP Kit

Repair Parts List

Part Number	Description
107059-01	Taco Variable Speed Pump
107058-01	Grundfos Variable Speed Pump
107061-01	2 Channel analog output Smart-Mod, 4-20/0-10V
107048-01	Junction Box Assembly
107051-01	Power Wiring Harness
107051-02	Communication Wiring Harness
107066-01	Flash Drive (Updated Display Software)